

Libellula

Pompe autodescanti a membrana

Self priming diaphragm pumps

Pompes auto-amorçantes á membrane

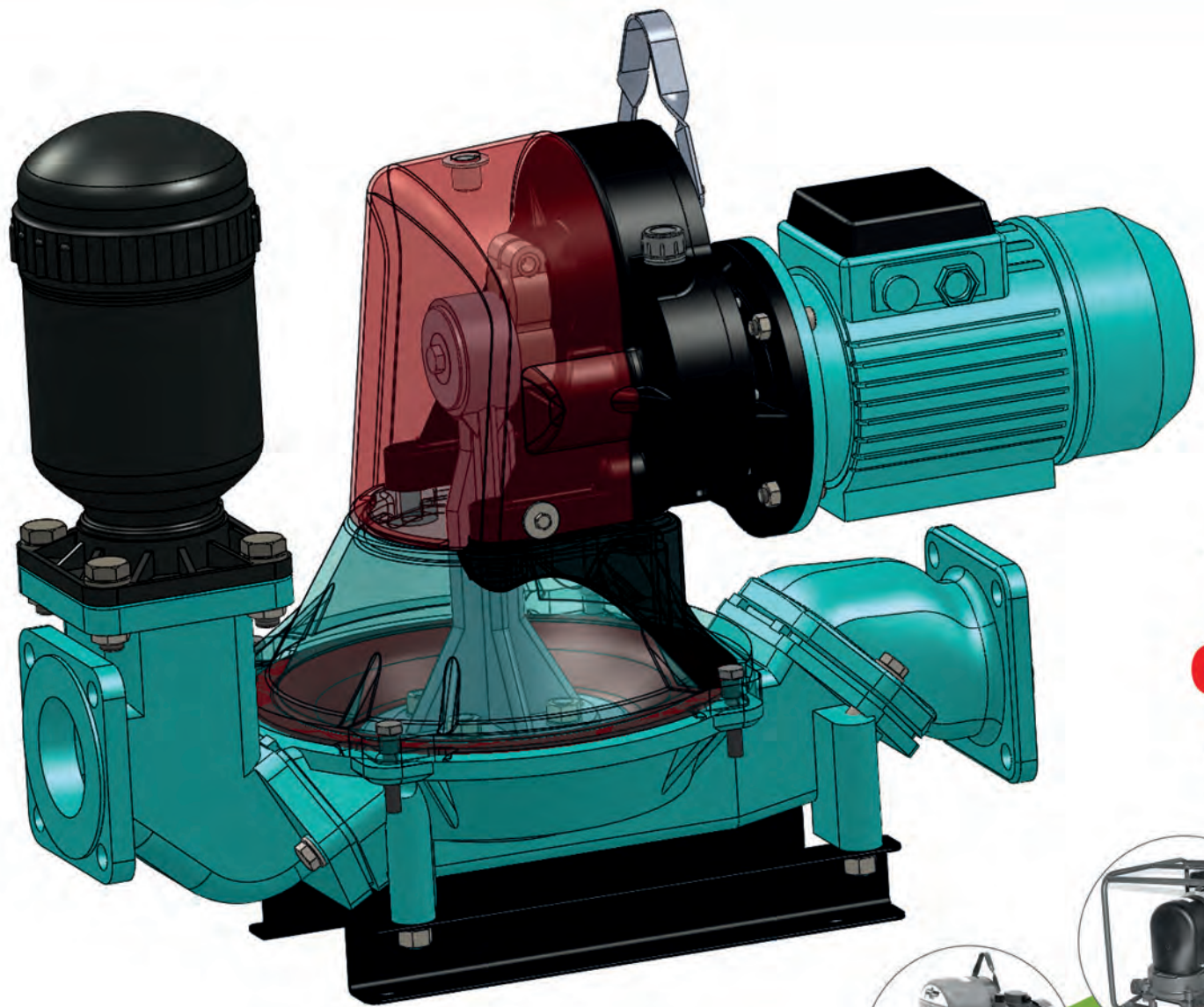

place & forget



Caffini
PUMPS

Libellula

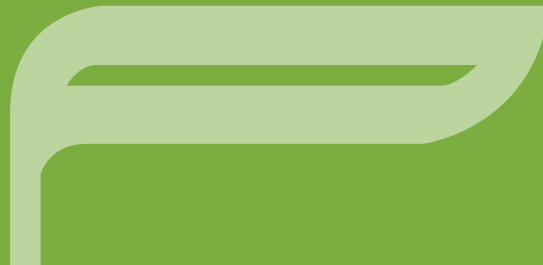

L'azienda nasce nel 1942 quando Cipriano Caffini intraprende una prima attività legata al commercio di macchine agricole. Ma è nel 1968 che ha inizio l'evoluzione dell'azienda verso la produzione di pompe a membrana. Fin dai primi anni l'azienda conquista un'ampia fetta di mercato estero, tanto che la diffusione del prodotto avviene per l'80% al di fuori dell'Italia. Dalla Francia all'Olanda, dagli Stati Uniti al Sud Africa, la qualità e l'efficacia della produzione si affermano e si consolidano finché la Caffini Pumps diviene la principale azienda del mondo nella produzione di pompe autoadescanti a membrana a bassa pressione. La crescita fa sì che l'azienda possa far fronte alle diverse esigenze nei campi dell'edilizia e dell'industria. Il 1995 è l'anno della prima produzione di pompe centrifughe autoadescanti Trash: semplice manutenzione, facile pulizia ed ottimi risultati in diversi campi d'applicazione distinguono le pompe della serie Trashlib. Ad oggi qualità e flessibilità continuano ad essere i maggiori punti di forza della nostra azienda.

The company was founded in 1942 when Cipriano Caffini started a first activity connected with the sale of agricultural machinery. But it was in 1968 that the company started its progression towards the manufacture of diaphragm pumps. Right from the first years the company won a large slice of the foreign market, to the extent that 80% of product distribution took place outside of Italy. From France to Holland, from the United States to South Africa, the quality and efficacy of our products were affirmed and consolidated until Caffini Pumps became the world's main manufacturer of low-pressure self-priming diaphragm pumps. The range of models is in continual expansion. The company's growth means it can deal with various requirements in the building and industrial fields. 1995 was the year we first manufactured our Trash self-priming centrifugal pumps: simple maintenance, easy cleaning and excellent results in various application fields distinguish the Trashlib pumps. Today, quality and flexibility continue to be our company's greatest assets.

L'entreprise est née en 1942 lorsque Cipriano Caffini entreprit une première activité liée au commerce de machines agricoles. Mais c'est en 1968 que l'entreprise connut une évolution vers la production de pompes à membrane. Dès les premières années, l'entreprise obtient une large part du marché étranger, à tel point que 80% du produit est diffusé en dehors de l'Italie. De la France à la Hollande, des États Unis à l'Afrique du Sud, la qualité et l'efficacité de la production s'imposent et se consolident. La Société Caffini Pumps est ainsi devenue la première entreprise mondiale dans la production de pompes auto-amorçantes à membrane à basse pression. La gamme des modèles est en expansion continue. Cette croissance permet à l'entreprise de répondre aux diverses exigences dans les secteurs du bâtiment et de l'industrie. En 1995, les premières pompes centrifuges auto-amorçantes Trash ont été fabriquées: un entretien et un nettoyage faciles, ainsi que des résultats optimaux dans divers champs d'application, voilà ce qui caractérise les pompes de la série Trashlib. Aujourd'hui, la qualité et la flexibilité restent les principaux points forts de notre entreprise.

Caratteristiche

- Possibilità di funzionare a secco.
- Rapido autoadescamento a secco fino a 7 mt. di profondità in pochi secondi,(5 mt per la serie SuperMicrolib).
- Nessuna tenuta o parte in rotazione a contatto del liquido pompato.
- Possibilità di impiego in presenza di fluidi abrasivi o acidi.
- Largo passaggio corpi solidi.
- Portata proporzionale al numero delle pulsazioni della membrana.
- Manutenzione semplicissima e saltuaria.

Features

- Indefinite dry-running capability.
- Rapid dry self-priming up to a depth of 7 metres in a matter of seconds, (5 mt for SuperMicrolib series).
- No seal or rotating part in contact with the pumped liquid.
- Can be used where there are abrasive or acid fluids.
- Wide passage for solid bodies.
- Flow rate proportional to number of diaphragm pulses.
- Very simple, occasional maintenance.

Caracteristiques

- Possibilité de fonctionnement à sec pour une durée indéterminée.
- Rapidité de l'auto-amorçage à sec, jusqu'à 7 mètres de profondeur en quelques secondes, (5 m pour la série SuperMicrolib).
- Aucune garniture ou partie en rotation n'est en contact avec le liquide pompé.
- Possibilité d'utilisation en présence de fluides abrasifs ou acides.
- Large passage de corps solides.
- Débit proportionnel au nombre de pulsations de la membrane.
- Entretien extrêmement simple et ne nécessitant pas de fréquence régulière.

Principio di funzionamento | Working principle | Principe de fonctionnement

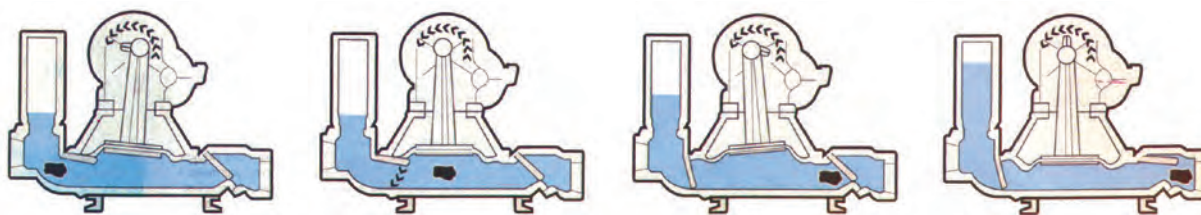

Le pompe a membrana serie Libellula e SuperMicrolib, sono del tipo alternativo volumetrico.

La membrana è fissata ad una biella mossa meccanicamente da una manovella montata sull'uscita di un riduttore di giri.

Lo spostamento di liquido nel corpo pompa generato dal movimento della membrana, è controllato in aspirazione ed in mandata da due valvole a clapet.

Nella fase di aspirazione, la membrana muovendosi verso l'alto, crea una depressione che richiama il liquido aprendo la valvola di aspirazione. Quando la membrana scende verso il basso, la valvola di aspirazione si chiude per gravità e contemporaneamente, il liquido viene espulso attraverso la valvola di mandata che si apre in questa fase.

È necessario, per questo tipo di pompe, che la tubazione di mandata sia di diametro adeguato e libera di scaricare il liquido pompato per evitare che la pressione di mandata oltrepassi il limite concesso, provocando rotture della membrana o danneggiamenti delle parti meccaniche.

Per evitare che le vibrazioni della pompa si trasmettano alle tubazioni, è consigliabile collegarla all'impianto con pezzi di tubo flessibile anti schiacciamento.

Diaphragm pumps series Libellula and SuperMicrolib, are reciprocating positive displacement pumps.

The membrane is fixed to a connecting rod, and mechanically moved by a crank mounted on the speed reducer output.

The displacement of liquid in the pump body, generated by the movement of the diaphragm, is controlled in suction and delivery by two check valves.

In the suction phase, the diaphragm moving upward creates a vacuum that draws the liquid by opening the inlet valve. When the diaphragm moves downwards, the inlet valve close by gravity and at the same time, the liquid is expelled through the outlet valve, which opens at this stage.

It is necessary, for this type of pump, that the pressure line is of a suitable diameter and free to discharge the pumped liquid, to prevent that the discharge pressure exceeds the granted limit, causing breakage of the membrane or mechanical parts damaging.

To prevent vibrations transmitted in the pipework from the running pump, it is advisable to connect the plant with flexible hose.

Les pompes à membrane Libellula et Super Microlib, sont du type alternatif volumétrique.

La membrane est fixée à une bielle déplacée mécaniquement par une manivelle montée sur la sortie d'un réducteur de vitesse.

Le déplacement du liquide dans le corps de pompe générée par le mouvement de la membrane, est commandé en aspiration et au refoulement, par deux clapets.

Dans la phase d'aspiration, la membrane se déplace vers le haut, crée une dépression qui aspire le liquide par l'ouverture du clapet d'aspiration. Quand la membrane se déplace vers le bas, le clapet d'aspiration se ferme par gravité et dans le même temps, le liquide est expulsé par le clapet de refoulement, qui ouvre à ce stade.

Et 'nécessaire, pour ce type de pompe, que les tuyaux de refoulement soient de diamètre approprié et libre de refouler le liquide pompé pour éviter que la pression de refoulement dépasse le limite accordée, provoquant la rupture de la membrane ou l'endommagement des pièces mécaniques.

Pour éviter les vibrations transmises de la pompe pendant le fonctionnement, il est conseillé de la raccorder à l'implant avec des morceaux de tuyau flexible.

Prestazioni | Performances | Performances

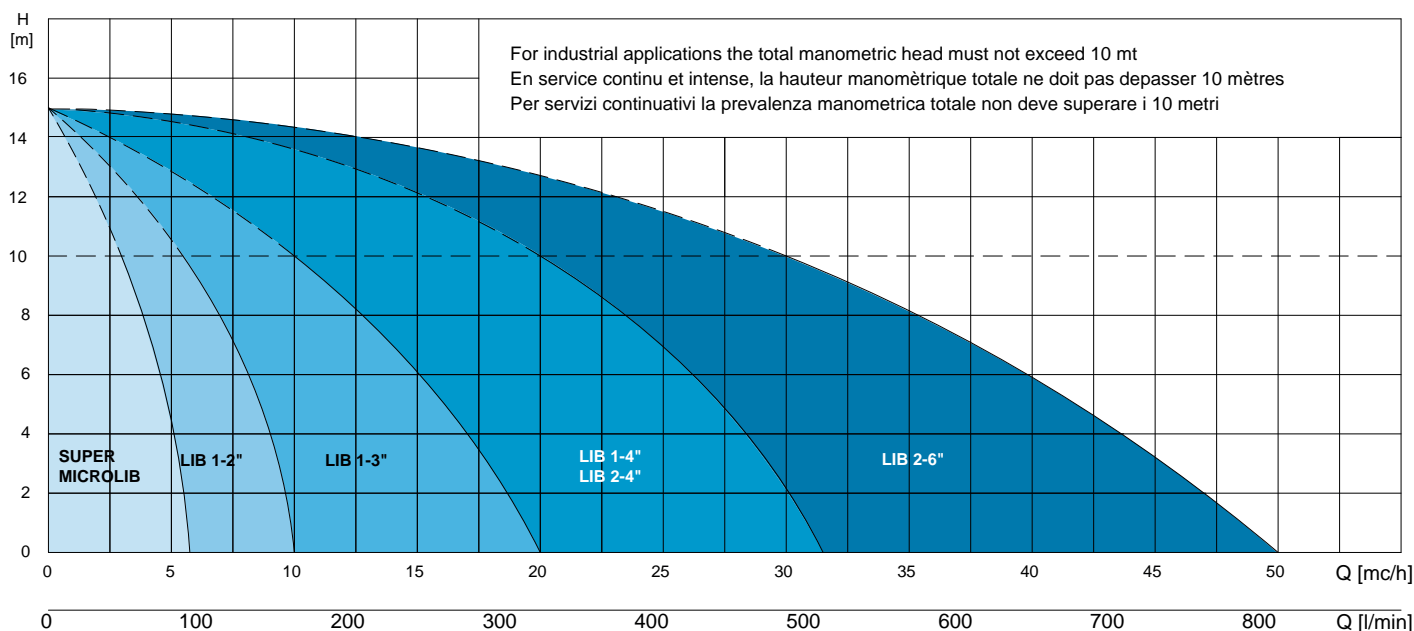



Principali applicazioni | Main applications | Applications principales

Edilizia, servizi municipali, ingegneria civile

Il settore edile dei lavori pubblici è quello nel quale le pompe a membrana Caffini Libellula hanno da sempre incontrato il massimo favore degli utilizzatori.

La capacità di funzionare a secco permette all'operatore di mantenere lo scavo asciutto anche in presenza di fango e solidi in sospensione. (Vedi foto a pagina 11)



Building industry, municipalities, civil engineering

The Caffini libellula diaphragm pumps have always been most greatly appreciated by their users in the building and public works sector. The capacity to run dry enables the operator to keep the ditch dry even when it contains mud and suspended solids. (See picture on page 11)



Constructions ediles, travaux publics, genie civil

Les pompes à membrane Caffini Libellula sont depuis toujours considérées comme le top pour les utilisateurs opérant dans le secteur du bâtiment et des travaux publics.

Leur capacité à fonctionner à sec permet à l'opérateur de conserver la fouille sèche également en présence de boue et de solides en suspension. (Voir photo à la page 11)

Drenaggio scavi nelle riparazioni di acquedotti, fognature, reti gas.
Prosciugamento scavi, pulizia pozzetti.
Pompaggio di bentonite e fanghi perforazione.

Drainage excavations in repairs of waterworks, sewers, gas networks.
Draining excavations, cleaning manholes. Pumping bentonite and drilling mud.

Drainage fouilles de dans la réparation des aqueducs et d'égouts, réseaux de gaz. Drainage de fouilles, nettoyage de puits. Pomper la boue de bentonite et forage.

Emergenza

Grazie alla loro elevata affidabilità le pompe a membrana Caffini Libellula sono particolarmente apprezzate per l'attività di soccorso in caso di calamità naturale. La possibilità di operare nonostante la presenza di detriti di grandi dimensioni rende queste macchine ideali per sgomberare cantine o altri ambiente da fango e acqua.

Emergency

Thanks to their absolute reliability the Caffini Libellula diaphragm pumps are particularly appreciated in emergency relief operations following natural calamities. The possibility to operate despite the presence of large pieces of waste makes these machines ideal for removing mud or water from cellars or other sites.

Emergence

Grâce à leur extrême fiabilité, les pompes à membrane Caffini Libellula sont particulièrement appréciées durant les opérations de secours en cas de calamité naturelle. Ces machines deviennent idéales pour évacuer la boue et l'eau dans des caves ou d'autres milieux, car elles peuvent fonctionner malgré la présence de débris de grandes dimensions.



Prosciugamento cantine, pulizia pozzetti e tombini.

Draining cellars, cleaning of wells and manholes.

Vidange des caves, le nettoyage des puits et des trous d'homme.

Depurazione acque

Le pompe a membrana vengono impiegate con successo nel campo della depurazione delle acque. Trovano infatti ideale applicazione nei flottatori in presenza di solidi, abrasivi e sostanze grasse in sospensione.



Water treatment industry

Diaphragm pumps are successfully used in the water purification field. They are excellent in flotation equipment applications in the presence of solids, abrasive substances or suspended fatty substances.



Épuration des eaux

Les pompes à membrane sont utilisées avec succès dans le secteur de l'épuration des eaux. Elles constituent en effet une application idéale pour les flotteurs en présence de solides, de produits abrasifs et de substances grasses en suspension.



Pompaggio fanghi, pulizia fosse biologiche, dosatura latte di calce, pompaggio acque di tintoria e impianti per taglio ad acqua (water jet cutting).

Sludge pumping, cleaning septic tanks, dosing lime milk, pumping water of dyeing plants and for water cutting (water jet cutting).

Pompage des boues, nettoyage des fosses septiques, dosage du lait de chaux, le pompage de l'eau de teinturerie, eau de coupage (coupage au jet d'eau).

Industria del marmo e della ceramica

Le pompe a membrana Caffini Libellula offrono grandi vantaggi nelle attività estrattive e in quelle legate alla lavorazione del marmo. La loro struttura è progettata per non risentire in alcun modo della grande abrasività della polvere di marmo o similari.

Marble and ceramics industry

The Caffini Libellula diaphragm pumps offer great advantages in extraction activities and in activities linked to the processing of marble. Their structure is designed not to be affected by the abrasiveness of marble dust or similar substances.

Industrie du marbre et céramique

Les pompes à membrane Caffini Libellula offrent de grands avantages pour les opérations d'extraction et celles liées à l'usinage du marbre.

Leur structure est conçue de façon à ne subir aucune conséquence de la grande abrasivité de la poussière de marbre ou semblables.



Pompaggio acque di taglio e levigazione, evacuazioni di fanghi decantati.

Cutting water pumping and processing, pumping out settled sludge.

Pompage de l'eau de taille et de dressage, évacuation de boues décantées.

Principali applicazioni | Main applications | Applications principales

Industria alimentare

Nell'ambito delle applicazioni nell'industria alimentare le caratteristiche delle pompe a membrana sono ideali per numerosi impieghi, alcuni dei quali comprendono il pompaggio polpa e scarti di pomodoro, succhi di frutta, sciroppi con noccioli o parti ghiacciate ancora presenti.



Pompaggio succhi di frutta, pomodoro, scarti di pomodoro, mosti.

Food industry

With regard to food industry applications, the technical specifications of the diaphragm pumps are ideal for numerous applications, some of which include the pumping of tomato pulp and waste, fruit juice, syrup still containing stones or frozen parts.

Industries alimentaires

Dans les secteurs de l'industrie alimentaire, les pompes à membrane présentent des caractéristiques qui sont idéales pour de nombreuses applications tel que le pompage de la pulpe et des rebuts de tomate, des jus de fruit, des sirops contenant encore des noyaux ou des morceaux congelés.



Pumping fruit juices, tomato, tomato waste, musts.

Pompage jus de fruit, tomate, les déchets de la tomate, des moûts.

Zootecnica ed allevamento

Le pompe a membrana Caffini Libellula vengono comunemente utilizzate dalle aziende del settore della zootecnica e dell'allevamento per l'aspirazione di sangue pulito o con scarti in sospensione, frattaglie di molti generi ricavate nella lavorazione dell'industria avicola.

Animal breeding industry

The Caffini Libellula diaphragm pumps are frequently used by companies in the zootechnical and breeding sector for the suction of clean blood or blood with suspended waste and offal of all kinds produced during the processing phases of poultry farming.

Elevage et abattoirs

Les pompes à membrane Caffini Libellula sont fréquemment utilisées par les entreprises opérant dans le secteur de la zootechnie et de l'élevage: elles permettent d'aspirer le sang propre ou contenant des rebuts en suspension, différents types d'abats provenant des activités de l'industrie avicole.



Pompaggio sangue e scarti di macellazione, aspirazioni liquami liquidi, fertilizzanti, mangimi liquidi.

Pumping blood and slaughterhouse waste, liquid manure, fertilizers, liquid feed.



Le pompage du sang et des déchets d'abattoirs, les aspirations de purin, des engrais, nourriture liquide.

Settore navale/aeronautico

Le pompe a membrana Caffini Libellula vengono ampiamente utilizzate sulle imbarcazioni come pompe di sentina e per lo svuotamento di serbatoi. In questa applicazione sono apprezzate le caratteristiche di assoluta affidabilità e la capacità di non risentire dei detriti di varia natura che possono causare il malfunzionamento di altre tecnologie.



Ship/aircraft industry

The Caffini Libellula diaphragm pumps are widely used on boats as bilge pumps and for emptying tanks. In this application, their total reliability and capacity not to be affected by all types of waste likely to cause malfunctions in other equipment are greatly appreciated.



Secteurs navals/aéronautiques

Les pompes à membrane Caffini Libellula sont énormément utilisées comme pompes de cale sur les embarcations et pour le vidage de réservoirs. Pour cette application, leurs caractéristiques d'extrême fiabilité et leur capacité à ne pas subir de conséquences négatives liées aux débris de différente nature qui pourraient entraîner le dysfonctionnement d'autres technologies sont essentielles.

Prosciugamento sentine, evacuazione liquami, pulizia serbatoi.

Draining bilges, evacuation of toilet sewage, tank cleaning.

Drainage sentine, évacuation des eaux usées, nettoyage du réservoir.

Industria meccanica e chimica

L'industria meccanica e chimica richiede macchine costantemente esposte a sostanze aggressive. Sicurezza e affidabilità sono garantite da un'ampia scelta di parti metalliche ed elastomeri, in base all'utilizzo con fluidi acidi o basici in presenza di abrasivi o corpi solidi.

Mechanical and chemical industry

The mechanical and chemical industry needs machinery that is constantly exposed to aggressive substance. Safety and reliability are guaranteed by a wide choice of parts in metal and elastomers, depending on whether they are to be used with acid or base fluids in presence of abrasives or solid bodies.

Industries chimique et mécanique

L'industrie chimique et mécanique nécessite de machines qui sont constamment en contact avec des substances agressives. En fonction de l'utilisation de fluides acides ou basiques en présence de produits abrasifs ou de corps solides, une large gamme de pièces métalliques et d'élastomères garantissent aux utilisateurs une sécurité et une fiabilité totales.

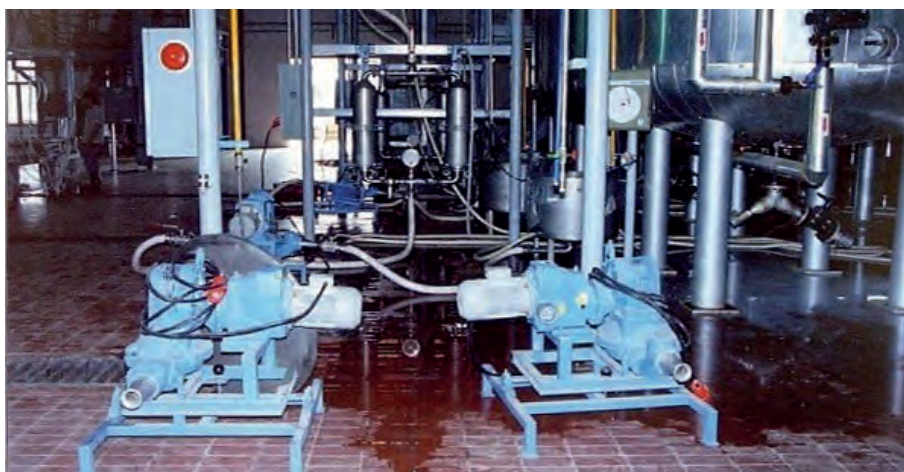

Pompaggio liquidi acidi o basici, vernici ad acqua, emulsioni, latex (produzione gomma).

Pumping acidic or basic liquids, water paints, emulsions, latex (rubber production).

Pomper le liquide acide ou basique, peintures à l'eau, émulsions, latex (production de caoutchouc).

Industria tessile

Le pompe a membrana dotate di valvole a clapet, come le pompe serie Libellula, grazie al grande passaggio di corpo solido, sono applicate per pompare le acque di scarico contenenti fibre, senza che la pompa ne abbia alcun danno. L'ampia scelta delle parti a contatto del liquido e delle parti in gomma, garantisce anche la resistenza alle sostanze chimiche presenti nel liquido.



Textile industry

The diaphragm pumps equipped with clapet valves, as the series Libellula pumps, thanks to the great passage of solid, are applied to pump wastewater containing fibers, without that the pump will have damage. The wide choice of the parts in contact with liquid and rubber parts, also ensures resistance to chemicals present in the liquid.

Industries textile

Les pompes à membrane équipés de vannes clapet, comme la série des pompes Libellula, grâce à le grand passage de corps solides, sont appliquées pour pomper les eaux usées contenant des fibres, sans que la pompe aura aucun dommage. Un vaste choix de pièces en contact avec des parties liquides et en caoutchouc, assure également une résistance aux produits chimiques présents dans le liquide.



Pompaggio liquidi provenienti da lavaggi o trattamenti di tessuti e fibre.

Pumping liquid from washing of textiles and fiber treatments.

Pompage liquide de lavage des textiles et des soins de fibres.

Industria della carta

Liquidi pastosi e densi, possono essere pompate facilmente con le pompe a membrana Libellula, che garantiscono anche l'esclusiva capacità di funzionare a secco per un tempo illimitato. Pezzi di legno e sporizia contenuti nel liquido, non pregiudicano affatto il buon funzionamento.

Paper industry

Pasty and thick liquids, can be easily pumped with diaphragm pumps Libellula, which also provide the unique ability to run dry indefinitely. Pieces of wood and dirt contained in the liquid, not at all hinder the proper functioning.

Industries du papier

Pâteux et liquides épais, peut être facilement pompé avec membrane pompes Libellula, qui fournissent également la capacité unique de fonctionner à sec indéfiniment. Des morceaux de bois et la saleté contenue dans le liquide, ne mettent pas en péril le bon fonctionnement.

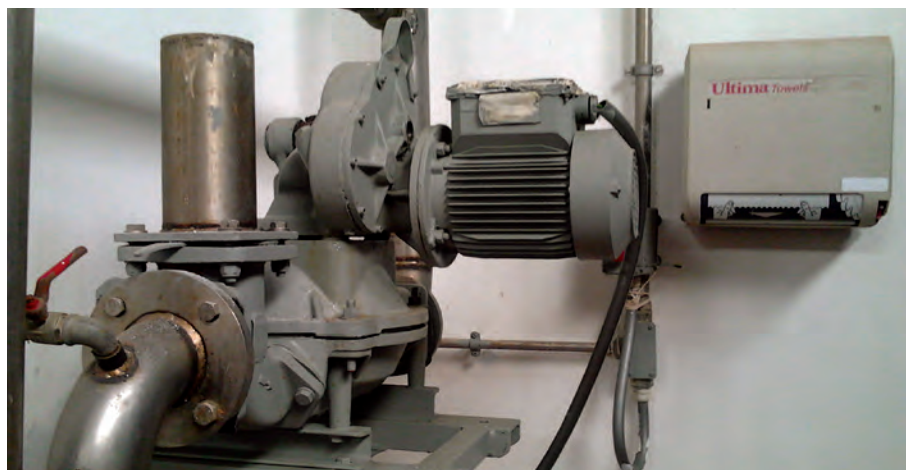

Pompaggio acqua contenente legno sminuzzato, pasta di legno.

Pumping water containing wood chips, wood pulp.

Pompage eau contenant de copeaux de bois, pâte à papier.



Programma di produzione | Production program | Programme de production

| Modello Type | Riduttore Reduction gear | Bocche Branches | | Max passaggio corpi solidi Max solids handling mm. | Max preval. manom. tot. Max total manom. head mt | Giri motore rpm motor | Pulsazioni minuto Strokes for minute | Potenza richiesta Power required Kw |
|---------------------------------|--------------------------------|--------------------------------|-------------|--|---|--------------------------|---|--|
| | | pollici inches Bsp or Npt | Dn | | | | | |
| LIBELLULA 1-3" | 1:43 | 3" | 80 PN10 | 50 | 15 | 2.800 | 65 | 1,5 |
| | | | | | | 1.400 | 32 | 1,5 |
| | | | | | | 900 | 21 | 1,1 |
| | | | | | | 700 | 16 | 0,75 |
| | 1:38 | 3" | 80 PN10 | 50 | 15 | 1.400 | 37 | 1,5 |
| | | | | | | 900 | 24 | 1,1 |
| | | | | | | 700 | 18 | 0,75 |
| | | | | | | 1.400 | 47 | 1,5 |
| | 1:30 | 3" | 80 PN10 | 50 | 15 | 900 | 30 | 1,1 |
| | | | | | | 700 | 23 | 0,75 |
| | | | | | | 2.800 | 65 | 1,1 |
| | | | | | | 1.400 | 32 | 1,1 |
| LIBELLULA 1-2" | 1:43 | 2" | - | 28 | 15 | 2.800 | 65 | 1,1 |
| SUPERMICROLIB 2" | 1:43 | 2" | - | 20 | 11 | 1.400 | 32 | 1,1 |
| | | | | | | 2.800 | 65 | 1,1 |
| LIBELLULA 2-4" | 1:43 | - | 100 PN10 | 50 | 15 | 2.800 | 65 | 3 |
| | | | | | | 1.400 | 32 | 3 |
| | | | | | | 900 | 21 | 2,2 |
| | | | | | | 700 | 16 | 1,5 |
| | 1:26 | - | 100 PN10 | 50 | 15 | 1.400 | 54 | 3 |
| | | | | | | 900 | 25 | 2,2 |
| | | | | | | 700 | 27 | 1,5 |
| | | | | | | 3.000 | 54 | 3 |
| LIBELLULA 1-4" | 1:55 | 4" | 100 PN10 | 60 | 15 | 1.400 | 25 | 2,2 |
| | | | | | | 900 | 16 | 1,5 |
| | | | | | | 1.400 | 45 | 3 |
| | | | | | | 900 | 29 | 2,2 |
| | 1:31 | 4" | 100 PN10 | 60 | 15 | 700 | 23 | 1,5 |
| | | | | | | 1.900 | 50 | 4,2 |
| | | | | | | 1.400 | 37 | 3 |
| | | | | | | 900 | 24 | 2,2 |
| | 1:38 | 4" | 100 PN10 | 60 | 15 | 700 | 18 | 1,5 |
| | | | | | | 1.400 | 46 | 5,5 |
| | | | | | | 900 | 30 | 4 |
| | | | | | | 700 | 23 | 3 |
| LIBELLULA 2-6" | 1:30,2 | - | 125 PN16 | 60 | 15 | 3.300 | 56 | 6 |
| | | | | | | 3.000 | 51 | 6 |
| | | | | | | 1.400 | 46 | 5,5 |
| | | | | | | 900 | 30 | 4 |
| | 1:58,5 | - | 125 PN16 | 60 | 15 | 700 | 23 | 3 |
| | | | | | | 2.800* | 61 | 0,37 |
| | | | | | | 1.400 | 56 | 0,37 |
| | | | | | | 900 | 36 | 0,25 |
| MICROLIB 2" (RETIRED) | 1:25 | 2" | - | 20 | 10 | 2.800* | 61 | 0,37 |
| | | | | | | 900 | 36 | 0,25 |

* Solo per motori a scoppio | Only for petrol engines | Seulement pour moteurs a essence.

Principali versioni | Main versions | Principales versions



| BUILDING VERSIONS | WETTED PARTS | NO WETTED PARTS | GEAR BOX TYPE | CONNECTING ROD |
|-------------------|----------------------|----------------------|---------------|---------------------------|
| LIBELLULA 1-3" | DIE-CASTED ALUMINIUM | DIE-CASTED ALUMINIUM | HELICAL TEETH | RIGID SELF LUBRICATED (1) |
| LIBELLULA 1-2" | POLYPROPYLENE | ALUMINIUM | HELICAL TEETH | RIGID SELF LUBRICATED |
| LIBELLULA 1-4" | ALUMINIUM | ALUMINIUM/CAST IRON | HELICAL TEETH | RIGID NOT SELF LUBRICATED |
| LIBELLULA 2-4" | ALUMINIUM | CAST IRON | HELICAL TEETH | RIGID SELF LUBRICATED (1) |
| LIBELLULA 2-6" | ALUMINIUM | CAST IRON | HELICAL TEETH | RIGID NOT SELF LUBRICATED |
| SUPERMICROLIB 2" | S.S. AISI 304 | ALUMINIUM | HELICAL TEETH | RIGID SELF LUBRICATED |

INDUSTRIAL VERSIONS

| | | | | |
|------------------|------------------------------|---------------------|---------------|---------------------------|
| LIBELLULA 1-3" | CAST IRON * | CAST IRON | HELICAL TEETH | RIGID SELF LUBRICATED (1) |
| LIBELLULA 1-2" | POLYPROPYLENE, S.S. AISI 316 | ALUMINIUM | HELICAL TEETH | RIGID SELF LUBRICATED |
| LIBELLULA 1-4" | CAST IRON * | ALUMINIUM/CAST IRON | HELICAL TEETH | RIGID NOT SELF LUBRICATED |
| SUPERMICROLIB 2" | S.S. AISI 304, S.S. AISI 316 | ALUMINIUM | HELICAL TEETH | RIGID SELF LUBRICATED |

* On request wetted parts in sea water resistant Aluminium, standard Aluminium, S.S. AISI 316, Bronze, Aluminium Rilsan Coated.

(1) On request available self lubricated with spring.

Le membrane e le valvole sono disponibili nei seguenti materiali: Neoprene®, Dutral®, Hypalon®, Viton®, gomma resistente agli oli, Tpv, Sarlink atossico®. Nelle applicazioni industriali l'altezza manometrica totale non deve essere superiore a 10 m.

Diaphragms and valves are available in Neoprene®, Dutral®, Hypalon®, Viton®, nitril rubber, TPV, atoxic Sarlink. For industrial applications the total manometric head must not exceed 10 mt.

Les membranes et les clapets sont disponibles dans les matériaux suivants: Néoprène®, Dutral®, Hypalon®, Viton®, caoutchouc nitrile, TPV, Sarlink atoxique. Pour les applications industrielles, la hauteur manométrique totale ne doit pas dépasser 10 m.

Flange e pignoni standard | Standard pinions and adapters | Brides et pignons standard

(Motori diesel in colore rosso) | (DIESEL engines in Red) AND WEIGHTS | (Moteurs DIESEL en couleur Rouge) ET POIDS
Tra parentesi il peso del motore | In brackets the engine weight | Entre parentheses le poids du moteur

| MOD./TYPE | LIBELLULA 1/3" | LIBELLULA 1/2" | LIBELLULA 2/4" | LIBELLULA 1/4" | LIBELLULA 2/6" | SUPERMICROLIB 2" |
|--------------------------|--------------------------|--------------------------|--------------------------|-----------------------------|------------------------|--------------------------|
| HONDA | GX160 (15) | GX160 (15) | GX270 (23,5) | GX160 L-R/GX270 (15) (23,5) | GX390 (31) | GX120 (13) |
| HATZ | 1B20-7 (28) | - | 1B30-6 (33) | 1B30-2 (33) | 1D50T22 (74) | - |
| LOMBARDINI DIESEL | 15LD225 (28) | - | 15LD350 (33) | 15LD350 (33) | 15LD440 (45) | - |
| LOMBARDINI KOHLER PETROL | COMMAND PRO CH260 (17,5) | COMMAND PRO CH260 (17,5) | COMMAND PRO CH295 (27,8) | COMMAND PRO CH295 (27,8) | COMMAND PRO CH440 (33) | COMMAND PRO CH260 (17,5) |
| BRIGGS & STRATTON | 750 Series (15,5) | 550 Series (14,5) | 1450 Series (25) | 1450 Series (25) | 2100 Series (31) | 550 Series (14,5) |
| ROBIN | EX13D (14) DY23D (30) | EX13D (14) | EX27 (21) | DY27B-2 (30) | - | EH09D (9,9) |
| YANMAR | L48AE-D (26) | - | L100AE-D (48) | L100AE-D (48) | L100AE-D (48) | - |
| KAWASAKI | FJ180D (17,5) | FJ130D (16,5) | - | - | - | - |
| PETTER | AC1 | - | AC1 | AD1 | AD1 | - |
| NEMA | C145TC | C145TC | C184TC | C184TC | - | - |
| ELECTRIC (1) | F90 B5 | F90 B5 | F100 B5 | F100/112 B5 | F132 B5 | F90 B5 |

(1) Per accoppiare alla pompa motori elettrici e variatori con la forma indicata non è necessaria la flangia.

(1) Fitting at the pump electric motors and speed variators the adapter is not necessary.

(1) Sur tous modèles le montage pompe/moteur/réducteur se fait sans bride d'adaptation.

Dimensioni di ingombro | Overall dimensions | Dimensions de encombrement

Allestimenti disponibili | Arrangements disponibles | Equipments disponibles

| Base fissa Stationary frame Chassis fixe | H | L | M | N | P | Q | R | T | F | G | Peso/Weight | Peso/Weight |
|---|------|-------|------|-----|-----|----|-----|-----|-----|-----|-------------|-------------|
| | | | | | | | | | | | Kg | Kg |
| | | | | | | | | | | | Alluminio | Ghisa |
| | | | | | | | | | | | Aluminium | Cast iron |
| LIB/1-3" THREADED | 619 | 691 | 352 | 101 | 135 | 50 | 510 | 320 | 325 | 195 | 36 | 77 |
| LIB/1-3" FLANGED | 614 | 681 | 352 | 101 | 135 | 50 | 510 | 320 | 325 | 195 | 44 | 79 |
| LIB/1-2" THREADED | 527 | 480 | 307 | 94 | 70 | 30 | 386 | 259 | 195 | 195 | 22 | - |
| SUPERMICROLIB-2" | 505 | 639 | 284 | 80 | 80 | 30 | 225 | 245 | 155 | 155 | 23 | - |
| LIB/1-4" THREADED | 630 | 840 | 410 | 170 | 180 | 50 | 660 | 420 | 325 | 285 | 72 | 102 |
| LIB/1-4" FLANGED | 630 | 890 | 410 | 170 | 180 | 50 | 660 | 420 | 325 | 285 | 74 | 110 |
| LIB/2-4" | 588 | 1160 | 705 | 200 | 200 | 38 | 740 | 418 | 325 | 195 | 137 | 210 |
| LIB/2-6" | 790 | 1430 | 850 | 248 | 263 | 38 | 890 | 546 | 325 | 285 | 288 | 432 |
| Microlib 2" (retired) | 330 | 580 | 420 | 75 | 75 | 30 | 360 | 240 | 155 | 155 | 16 | - |
| Barella portatile Carrying frame Chassis portatif | | | | | | | | | | | | |
| LIB/1-3" | 565 | 685 | 645 | 160 | 194 | - | 510 | 375 | 325 | 195 | 37 | - |
| LIB/1-3" Wraparound | 685 | 967,5 | 485 | 130 | 164 | - | 375 | 343 | 325 | 195 | 54 | - |
| SuperMicrolib 2" Wrap. | 550 | 650 | 450 | 72 | 72 | - | 280 | 237 | 155 | 155 | 31 | - |
| Carrello per motore elettrico o scoppio Trailer for petrol or electric motor Chariot pour moteur essence ou électrique | | | | | | | | | | | | |
| LIB/1-3" in line with rubberized wheels | 687 | 1175 | 590 | 221 | 255 | - | 365 | 435 | 325 | 195 | 54 | - |
| LIB/1-3" Simply with pneumatic wheels | 637 | 881 | 505 | 162 | 186 | - | 656 | 368 | 322 | 177 | 44 | - |
| LIB/1-3" Wraparound | 815 | 935 | 685 | 253 | 287 | - | 340 | 570 | 325 | 195 | 60 | - |
| LIB/1-2" in line with pneumatic wheels | 637 | 881 | 501 | 152 | 126 | - | 646 | 315 | 195 | 195 | 28 | - |
| LIB/1-4" Wraparound | 870 | 1065 | 750 | 260 | 295 | - | 720 | 520 | 325 | 285 | 106 | - |
| LIB/1-4" Wraparound for Honda Gx270 | 870 | 1065 | 870 | 260 | 295 | - | 720 | 520 | 325 | 285 | 112 | - |
| LIB/2-4" drawbar | 750 | 1160 | 940 | 400 | 315 | - | 747 | 640 | 325 | 195 | 170 | 243 |
| LIB/2-6" drawbar | 1050 | 1430 | 1170 | 508 | 367 | - | 890 | 806 | 325 | 285 | 300 | 459 |
| SuperMicrolib 2" Wraparound | 635 | 935 | 555 | 215 | 215 | - | 365 | 375 | 155 | 155 | 30 | - |
| Microlib 2" (retired) | 415 | 1080 | 420 | 175 | 175 | - | 340 | 340 | 155 | 155 | 21 | - |
| Carrello per motore diesel Trailer for diesel engine Chariot pour moteur diesel | | | | | | | | | | | | |
| LIB/1-3" Wraparound | 815 | 935 | 685 | 253 | 287 | - | 340 | 570 | 325 | 195 | 68 | - |
| LIB/1-4" Wraparound | 870 | 1065 | 750 | 260 | 295 | - | 720 | 520 | 325 | 285 | 112 | - |
| LIB/2-4" drawbar | 750 | 1160 | 940 | 400 | 315 | - | 747 | 640 | 325 | 195 | 170 | 243 |
| LIB/2-6" drawbar | 1050 | 1430 | 1170 | 508 | 367 | - | 890 | 806 | 325 | 285 | 300 | 459 |

Pesi senza motori | Weights without engines | Poids sans moteurs.

Dimensioni espresse in mm | Dimensions expressed in millimeters | Dimensions exprimées en mm.

Versioni acciaio inox pesanti 5% più della ghisa | Stainless steel versions are approx. 5% heavier than cast iron | Versions en acier inox sont plus lourdes de 5% que en fonte.

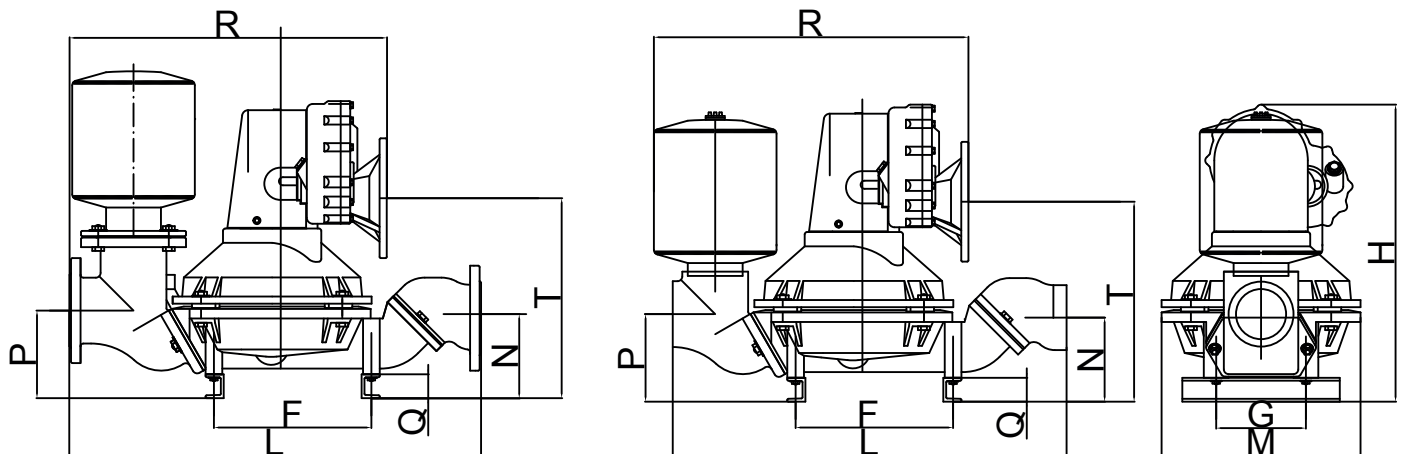



Caffini Cipriano S.r.l.

Via G. di Vittorio, 46 - 43044 (Cavalli) Lemignano di Collecchio (Parma) - Italy

Tel.: 0521 804325 - Fax: 0521 804145

E-mail: info@caffinipumps.it

www.caffinipumps.it

